

# TP-LINK®

## User Guide

### TL-WA860RE

### 300Mbps Wi-Fi Range Extender with AC Passthrough



REV.:1.4.0

1910011322

## COPYRIGHT & TRADEMARKS

Specifications are subject to change without notice. **TP-LINK**<sup>®</sup> is a registered trademark of TP-LINK TECHNOLOGIES CO., LTD. Other brands and product names are trademarks or registered trademarks of their respective holders.

No part of the specifications may be reproduced in any form or by any means or used to make any derivative such as translation, transformation, or adaptation without permission from TP-LINK TECHNOLOGIES CO., LTD. Copyright © 2015 TP-LINK TECHNOLOGIES CO., LTD.

All rights reserved.

<http://www.tp-link.com>

## FCC STATEMENT



This equipment has been tested and found to comply with the limits for a Class B digital device, pursuant to part 15 of the FCC Rules. These limits are designed to provide reasonable protection against harmful interference in a residential installation. This equipment generates, uses and can radiate radio frequency energy and, if not installed and used in accordance with the instructions, may cause harmful interference to radio communications. However, there is no guarantee that interference will not occur in a particular installation. If this equipment does cause harmful interference to radio or television reception, which can be determined by turning the equipment off and on, the user is encouraged to try to correct the interference by one or more of the following measures:

- Reorient or relocate the receiving antenna.
- Increase the separation between the equipment and receiver.
- Connect the equipment into an outlet on a circuit different from that to which the receiver is connected.
- Consult the dealer or an experienced radio/ TV technician for help.

This device complies with part 15 of the FCC Rules. Operation is subject to the following two conditions:

- 1) This device may not cause harmful interference.
- 2) This device must accept any interference received, including interference that may cause undesired operation.

Any changes or modifications not expressly approved by the party responsible for compliance could void the user's authority to operate the equipment.

Note: The manufacturer is not responsible for any radio or tv interference caused by unauthorized modifications to this equipment. Such modifications could void the user's authority to operate the equipment.

## FCC RF Radiation Exposure Statement

This equipment complies with FCC RF radiation exposure limits set forth for an uncontrolled environment. This device and its antenna must not be co-located or operating in conjunction with any other antenna or transmitter.

"To comply with FCC RF exposure compliance requirements, this grant is applicable to only Mobile Configurations. The antennas used for this transmitter must be installed to provide a separation distance of at least 20 cm from all persons and must not be co-located or operating in conjunction with any other antenna or transmitter."

## CE Mark Warning

# CE 1588

This is a class B product. In a domestic environment, this product may cause radio interference, in which case the user may be required to take adequate measures.

## Canadian Compliance Statement

This device complies with Industry Canada license-exempt RSS standard(s). Operation is subject to the following two conditions:

- (1) This device may not cause interference, and
- (2) This device must accept any interference, including interference that may cause undesired operation of the device.

Cet appareil est conforme aux norms CNR exemptes de licence d'Industrie Canada. Le fonctionnement est soumis aux deux conditions suivantes:

- (1) cet appareil ne doit pas provoquer d'interférences et
- (2) cet appareil doit accepter toute interférence, y compris celles susceptibles de provoquer un fonctionnement non souhaité de l'appareil.

## Industry Canada Statement

Complies with the Canadian ICES-003 Class B specifications.

Cet appareil numérique de la classe B est conforme à la norme NMB-003 du Canada.

This device complies with RSS 210 of Industry Canada. This Class B device meets all the requirements of the Canadian interference-causing equipment regulations.

Cet appareil numérique de la Classe B respecte toutes les exigences du Règlement sur le matériel brouilleur du Canada.

## Korea Warning Statements

당해 무선설비는 운용중 전파혼신 가능성이 있음.

## NCC Notice & BSMI Notice

注意！

依據 低功率電波輻射性電機管理辦法

第十二條 經型式認證合格之低功率射頻電機，非經許可，公司、商號或使用者均不得擅自變更頻率、加大功率或變更原設計之特性或功能。

第十四條 低功率射頻電機之使用不得影響飛航安全及干擾合法通行；經發現有干擾現象時，應立即停用，並改善至無干擾時方得繼續使用。前項合法通信，指依電信規定作業之無線電信。低功率射頻電機需忍受合法通信或工業、科學以及醫療用電波輻射性電機設備之干擾。

減少電磁波影響，請妥適使用。

安全諮詢及注意事項

- 請使用原裝電源供應器或只能按照本產品注明的電源類型使用本產品。

- 清潔本產品之前請先拔掉電源線。請勿使用液體、噴霧清潔劑或濕布進行清潔。
- 注意防潮，請勿將水或其他液體潑灑到本產品上。
- 插槽與開口供通風使用，以確保本產品的操作可靠並防止過熱，請勿堵塞或覆蓋開口。
- 請勿將本產品置放於靠近熱源的地方。除非有正常的通風，否則不可放在密閉位置中。
- 請不要私自打開機殼，不要嘗試自行維修本產品，請由授權的專業人士進行此項工作。



Продукт сертифіковано згідно з правилами системи УкрСЕПРО на відповідність вимогам нормативних документів та вимогам, що передбачені чинними законодавчими актами України.



## Safety Information

- When product has power button, the power button is one of the way to shut off the product; when there is no power button, the only way to completely shut off power is to disconnect the product or the power adapter from the power source.
- Don't disassemble the product, or make repairs yourself. You run the risk of electric shock and voiding the limited warranty. If you need service, please contact us.
- Avoid water and wet locations.

This product can be used in the following countries:

AT	BG	BY	CA	CZ	DE	DK	EE
ES	FI	FR	GB	GR	HU	IE	IT
LT	LV	MT	NL	NO	PL	PT	RO
RU	SE	SK	TR	UA	US		

## DECLARATION OF CONFORMITY

For the following equipment:

Product Description: **300Mbps Wi-Fi Range Extender with AC Passthrough**

Model No.: **TL-WA860RE**

Trademark: **TP-LINK**

We declare under our own responsibility that the above products satisfy all the technical regulations applicable to the product within the scope of Council Directives:

Directives 1999/5/EC, Directives 2004/108/EC, Directives 2006/95/EC, Directives 1999/519/EC, Directives 2011/65/EU

The above product is in conformity with the following standards or other normative documents

**EN 300 328 V1.8.1**

**EN 301 489-1 V1.9.2 & EN 301 489-17 V2.2.1**

**EN 55022: 2010 + AC: 2011**

**EN 55024: 2010**

**EN 61000-3-2: 2006 + A1: 2009 + A2: 2009**

**EN 61000-3-3: 2013**

**EN 60950-1: 2006 + A11: 2009 + A1: 2010 + A12: 2011**

**EN 50385: 2002**

*The product carries the CE Mark:*

**CE 1588**

Person responsible for making this declaration:



**Yang Hongliang**

**Product Manager of International Business**

Date of issue: 2015

TP-LINK TECHNOLOGIES CO., LTD.

Building 24 (floors 1, 3, 4, 5), and 28 (floors 1-4) Central Science and Technology Park,  
Shennan Rd, Nanshan, Shenzhen, China

# CONTENTS

<b>Package Contents .....</b>	<b>1</b>
<b>Chapter 1 Introduction.....</b>	<b>2</b>
1.1 Product Overview .....	2
1.2 Main Features .....	2
1.3 Appearance.....	2
<b>Chapter 2 Hardware Installation .....</b>	<b>4</b>
2.1 Before You Begin .....	4
2.2 Basic Requirements .....	5
2.3 Connecting the Device .....	5
<b>Chapter 3 Quick Installation Guide.....</b>	<b>6</b>
<b>Chapter 4 Configure the Device.....</b>	<b>10</b>
4.1 Status.....	10
4.2 Quick Setup.....	11
4.3 Profile.....	11
4.4 Network.....	13
4.4.1 LAN.....	13
4.4.2 DHCP Settings.....	14
4.4.3 DHCP Client List.....	16
4.5 Wireless .....	16
4.5.1 Wireless Settings.....	17
4.5.2 Wireless Security.....	18
4.5.3 Wireless MAC Filtering .....	20
4.5.4 Wireless Advanced.....	22
4.5.5 Wireless Statistics.....	23
4.5.6 Throughput Monitor .....	24
4.6 System Tools.....	25
4.6.1 Firmware Upgrade .....	25
4.6.2 Factory Defaults.....	26
4.6.3 Backup & Restore.....	26
4.6.4 Reboot .....	27
4.6.5 Password.....	28
4.6.6 System Log.....	28
<b>Appendix A: Factory Defaults .....</b>	<b>30</b>
<b>Appendix B: Troubleshooting.....</b>	<b>31</b>
<b>Appendix C: Specifications.....</b>	<b>33</b>
<b>Appendix D: Glossary.....</b>	<b>34</b>

## Package Contents

The following items should be found in your package:

- TL-WA860RE 300Mbps Wi-Fi Range Extender with AC Passthrough
- Ethernet Cable
- Quick Installation Guide

 **Note:**

Make sure that the package contains the above items. If any of the listed items is damaged or missing, please contact your distributor.

## Conventions

The Range Extender, the Device or TL-WA860RE mentioned in this User guide stands for TL-WA860RE 300Mbps Wi-Fi Range Extender with AC Passthrough without any explanations.

Parameters provided in the pictures are just references for setting up the product, which may differ from the actual situation. You can set the parameters according to your demand.

**The power plug may differ from the picture illustrated in this UG due to different regional power specifications. As follows we just take that of EU version for example.**



# Chapter 1 Introduction

## 1.1 Product Overview

The TL-WA860RE 300Mbps Wi-Fi Range Extender with AC Passthrough is dedicated to Small Office/Home Office (SOHO) wireless network solutions. It will enlarge your existing wireless network and mobility within your wireless network while also allowing you to connect a wired device to a wireless environment. Increased mobility and the absence of cabling will be beneficial for your network.

With using IEEE 802.11n wireless technology, this device can transmit wireless data at the rate of up to 300Mbps. With multiple protection measures, including wireless LAN 64/128/152-bit WEP encryption, Wi-Fi protected Access (WPA2-PSK, WPA-PSK), the TL-WA860RE 300Mbps Wi-Fi Range Extender with AC Passthrough delivers complete data privacy.

It supports an easy wireless connection to the root AP (equipped with WPS/QSS button) by pressing the RE button on the front panel. It also supports an easy, web-based setup for installation and management. Even though you may not be familiar with the Range Extender, you can easily configure it with the help of this Guide. Before installing the Range Extender, please look through this Guide to get the full information of the TL-WA860RE 300Mbps Wi-Fi Range Extender with AC Passthrough.

## 1.2 Main Features

- Make use of IEEE 802.11n wireless technology
- Provides multiple encryption security Types including: 64/128/152-bit WEP and WPA-PSK/WPA2-PSK
- Supports Built-in DHCP server
- Supports one operating modes: Range Extender
- Supports Firmware Upgrade
- Supports Web management

## 1.3 Appearance

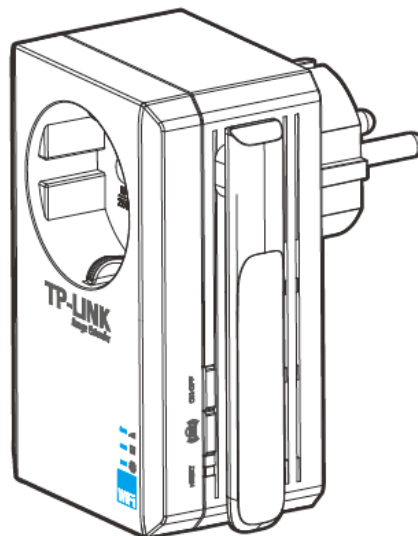

Figure 1-1

● **LED Explanation:**





Name	Status	Indication
Signal 	Off	TL-WA860RE isn't connected to the router.
	Flashing Green	TL-WA860RE is connecting to the router.
	Solid Green	TL-WA860RE is connected to the router and is in a good location.
	Flashing Orange	TL-WA860RE is connected to the router but is too far away from the router.
	Solid Orange	TL-WA860RE is connected to the router but is too close to the router.
Ethernet 	Off	No device is connected to the ETHERNET port.
	Green	A device is connected to the ETHERNET port.
Power 	Off	TL-WA860RE is off.
	Orange	TL-WA860RE is booting.
	Green	TL-WA860RE is on.

Table 1-1

- **RESET:** This button is used to restore the Range Extender’s factory default settings.  
There are two ways to reset the Range Extender’s factory defaults:  
**Method One:** With the Range Extender powered on, press and hold the **RESET** button (about 6 seconds) until all the LEDs turn on momentarily, then release the button and wait the Range Extender to reboot to its factory default settings.  
**Method Two:** Restore the default settings from “**System Tools > Factory Defaults**” of the Range Extender's Web-based management page.
-  (**RANGE EXTENDER/WPS**): If your Wireless router or AP supports WPS or QSS function, you can press the WPS or QSS button and then press the RANGE EXTENDER button to establish a secure connection between the Wireless router (or AP) and the Range Extender TL-WA860RE.
- **ON/OFF:** The switch for the power.
- **ETHERNET:** One 10/100Mbps RJ45 Ethernet port used to add wireless connectivity to an Ethernet-enabled device such as Internet TV, DVR, Gaming console and so on. Please note that this port is not allowed to be connected with router or AP.

## Chapter 2 Hardware Installation

### 2.1 Before You Begin

Please read this User Guide carefully before installing and using the equipment. The operating distance range of your wireless connection can vary significantly depending on the physical position of the wireless devices. Factors that can weaken signals by getting in the way of your network's radio waves are metal appliances or obstructions, and walls. Typical ranges vary based on the types of materials and background RF (radio frequency) noise in your home or office.

In order to optimize the performance of TL-WA860RE, please follow the instructions below to achieve **an ideal location** (please make sure it is always within the wireless coverage of the wireless router).

- 1) *Half-way Between* - Generally, the ideal location for TL-WA860RE is half-way between the Wireless router and Wireless Client. If the wireless signal is not satisfactory, you may place TL-WA860RE somewhat nearer to the Wireless router.

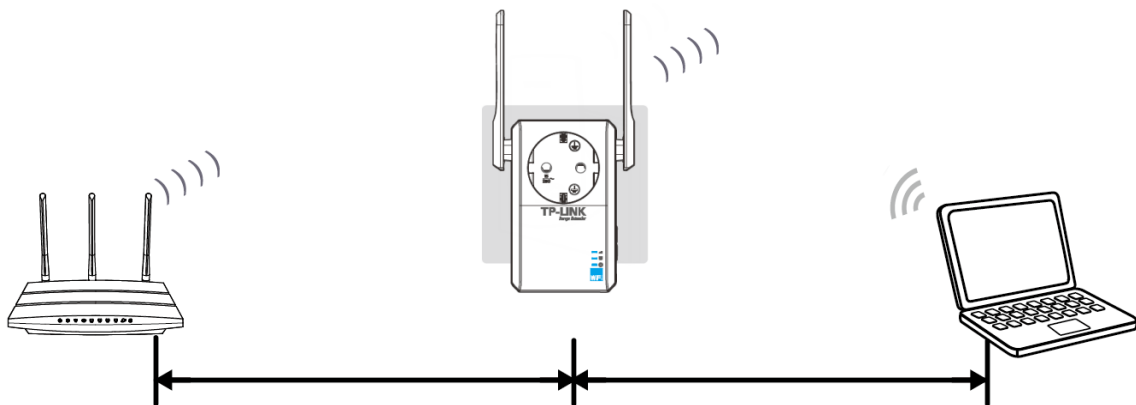

- 2) *No Obstacles and Spacious* - Clear obstacles in the way between TL-WA860RE and Wireless router. It's better to locate it in a spacious place, such as near the corridors.
- 3) *No Interference* - Keep TL-WA860RE far away from wireless interference, which may come from electrical appliances that works in the same frequency band as TL-WA860RE, such as Blue tooth devices, cordless phones, microwave ovens, etc.
- 4) *Signal LED Indication*- Make sure your extender is in a location where the Signal LED is solid green. Solid orange means TL-WA860RE is too close to your main Router/AP; flashing orange means far from your main Router/AP.

#### Note:

TP-LINK recommends that you connect to the Range Extender *when* your home network connection is poor, or when you want a larger wireless coverage to eliminate “dead zones”. As in compliance with the wireless transmission protocol, all the Range Extender devices are set to work in half-duplex instead of full-duplex mode. In other words, the Range Extender has to process one-way communication between your root Wireless router (or AP) and the terminal clients; so the transmission time will be double-increased, while the speed will be decreased.

## 2.2 Basic Requirements

- Place your Range Extender in a well-ventilated place far from direct sunlight, any heater or heating vent.
- Leave at least 2 inches (5cm) space around the device for heat dissipation.
- Turn off your Range Extender and unplug the power adapter in a lightning storm to avoid damage.
- Use Web browser, such as Microsoft Internet Explorer 5.0 or above, Netscape Navigator 6.0 or above.
- Operating temperature of the Range Extender should be 0°C~40°C (32°F~104°F).
- Operating humidity of the Range Extender should be 10%~90%RH (Non-condensing).

## 2.3 Connecting the Device

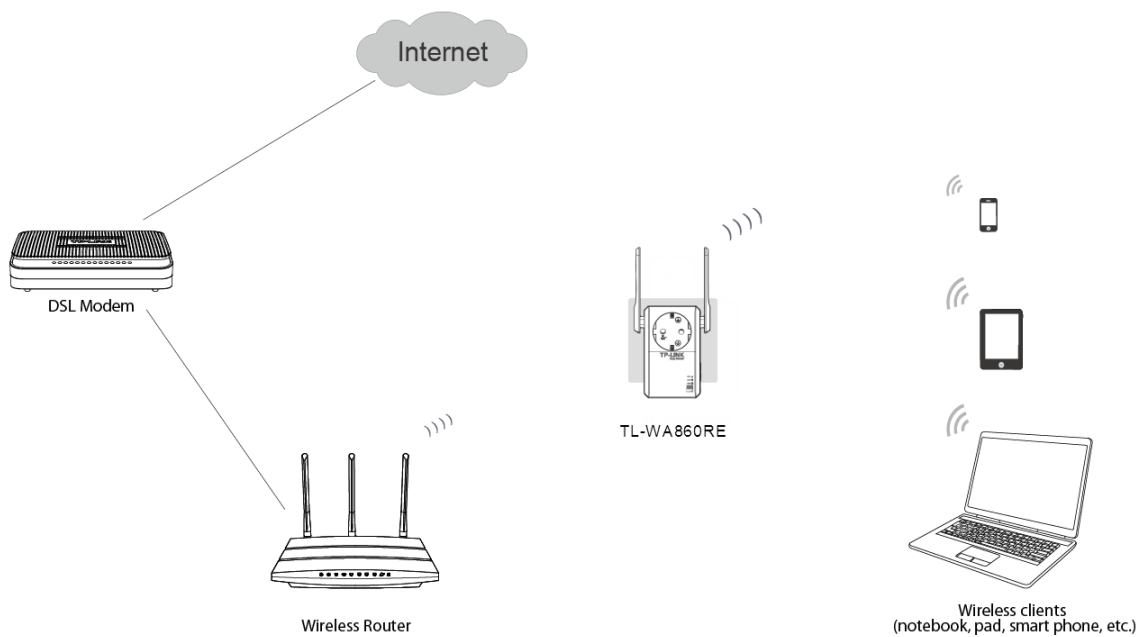

Figure 2-1 Typical connection of TL-WA860RE

To establish a typical connection of the Range Extender, please take the following steps:

1. Connect the Cable/DSL modem to a Wireless router with an Ethernet cable.
2. Plug your TL-WA860RE directly to a standard electrical wall socket, which is next to the Wireless router.
3. Connect your Wireless Clients (such as notebook, pad, smart phone, etc.) to TL-WA860RE wirelessly. Or you can connect your PC to the sole LAN port of Range Extender via an Ethernet cable.
4. Log in the web-based management page of TL-WA860RE and complete the configurations. (Please refer to [Chapter 3 Quick Installation Guide](#) or [Chapter 4 Configure the Device](#) for the configurations, as you need.) Through the web page configuration you can successfully connect TL-WA860RE to the wireless router.
5. Adjust an ideal location for TL-WA860RE. (Please refer to Section [2.1 Before You Begin](#) for detailed information about ideal location.)

## Chapter 3 Quick Installation Guide

This chapter will guide you to configure your PC to communicate with the Range Extender and to configure and manage the TL-WA860RE 300Mbps Wi-Fi Range Extender with AC Passthrough easily with a Web-based utility.

With a Web-based utility, it is easy to configure and manage the TL-WA860RE 300Mbps Wi-Fi Range Extender with AC Passthrough. The Web-based utility can be used on any Windows, Macintosh or UNIX OS with a Web browser, such as Microsoft Internet Explorer, Mozilla Firefox or Apple Safari.

1. To access the configuration utility, open a web-browser and type in the domain name <http://tplinkrepeater.net> in the address field of the browser.

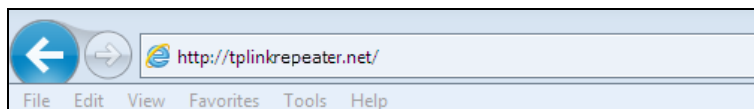

Figure 3-1 Login to the Range Extender

After a moment, a login window will appear as shown in Figure 3-2. Enter **admin** for the User Name and Password (both in lower case letters). Then click **OK** or press Enter.



Figure 3-2 Login Windows

### Note:

If the above screen does not prompt, it means that your web-browser has been set to a proxy. Go to **Tools menu>Internet Options>Connections>LAN Settings**, in the screen that appears, cancel the **Using Proxy** checkbox, and click **OK** to finish it.

- After successful login, there will pop up the **Quick Setup Start** page. Click **Next** to get the quick setup started.

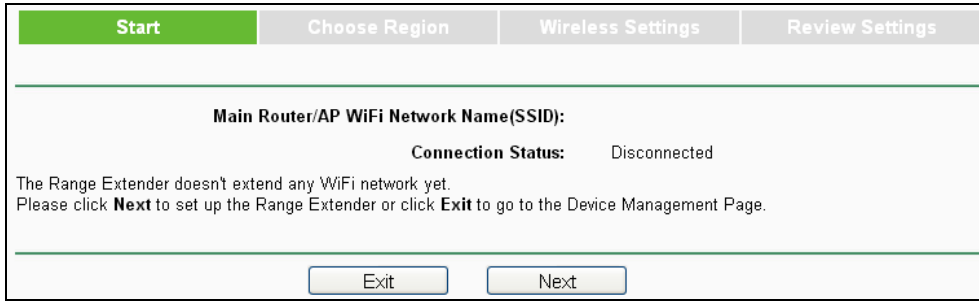

Figure 3-3 Quick Setup Start

**Note:**

If you are not to go through the Quick Setup right away, you can click **Exit** and enter the main menu of the device.

- Figure 3-4 will appear for you to choose the region. Then click **Next** to continue.



Figure 3-4 Quick Setup – Choose Region and Mode

**Note:**

Per FCC regulations, all Wi-Fi products marketed in the U.S. must be fixed to the U.S. region only.

- The device will detect the existing network. Please wait for a while.



Figure 3-5 Quick Setup – Detect Existing Network

- A list of available wireless network will appear. Check the box before the SSID of your desired network, and then click **Next**.

Choose	SSID	Signal	MAC	Channel	Security
<input type="checkbox"/>	TP-LINK_FCFC7B	Signal strength bars	32-85-A9-E8-BF-71	1	None
<input checked="" type="checkbox"/>	TP-LINK_Network	Signal strength bars	32-85-A9-E8-BF-73	1	WPA-PSK
<input type="checkbox"/>	Wireless_137B00	Signal strength bars	00-0A-EB-13-7B-00	6	None
<input type="checkbox"/>	Network-10444FA2	Signal strength bars	32-85-A9-E8-BF-72	1	None
<input type="checkbox"/>	TP-LINK_130919	Signal strength bars	30-85-A9-E8-BF-70	1	WPA2-PSK
<input type="checkbox"/>	TP-LINK_104214	Signal strength bars	00-1D-0F-01-50-90	9	None
<input type="checkbox"/>	TP-LINK_D1CF8A	Signal strength bars	64-70-02-78-9C-9A	6	WPA-PSK

Set SSID and MAC Manually

Figure 3-6 Quick Setup – Available Wireless Networks

**Note:**

If you could not find your wireless network name (SSID) in the list, you can click **Rescan** to redetect it or tick the checkbox before "Set SSID and MAC Manually" to manually configure the wireless settings.

- Wireless Settings page will appear as shown in Figure 3-7. Enter the WiFi Password of your main router/AP, name your range extender WiFi network or keep it default, and then click **Next** to continue.

Main Router/AP WiFi Network Name(SSID): TP-LINK\_Network

Main Router/AP MAC Address(BSSID): 94-0C-6D-2F-3C-BE

WiFi Security Option: Most Secure(WPA-PSK/WPA2-PS)

Fill in the WiFi Password of your Main Router/AP: [Text Input]

Range Extender WiFi Network Name(SSID):  Copy from Main Router/AP  Customize

TP-LINK\_Network

Figure 3-7 Quick Setup – Wireless Settings

7. Double-check your wireless setting and network setting, when Figure 3-8 appears. If verified, click **Finish** to complete the Quick Setup. If there is anything wrong, click **Back** to return the previous pages and reconfigure it.

Start	Choose Region	Wireless Settings	Review Settings
<p>The Quick Setup configuration is finished. Please double check the settings below. If anything is wrong, please click "Back" to re-configure.</p>			
<p><b>Wireless Setting</b></p> <p>Operation Mode: Universal Mode</p> <p>Main Router/AP WiFi Network Name(SSID): TP-LINK_Network</p> <p>Main Router MAC Address: 94-0C-6D-2F-3C-BE</p> <p>Range Extender WiFi Network Name(SSID): TP-LINK_Network_EXT</p> <p>WiFi Security Option: Most Secure(WPA/WPA2-PSK)</p> <p>WiFi PassWord: 751953852</p>			
<p><b>Network Setting</b></p> <p>Default Access: http://tplinkextender.net</p> <p>Login Username: admin</p> <p>Login Password: admin</p>			
<p>Export Settings</p>		<p>Back Finish</p>	

Figure 3-8 Quick Setup – Review Settings

**Note:**

It's recommended to click the **Export Settings** button to save these settings as a txt file for your future reference.

8. When the Range Extender is applying the wireless settings (as shown in Figure 3-9), please wait for a while patiently until Figure 3-10 appears. Then you have successfully extended the root device's wireless signal.

Start	Choose Region	Wireless Settings	Review Settings
<p>The Range Extender is applying the wireless settings.</p> <p>Please wait about two minutes...</p> <p>40%</p>			

Figure 3-9 Quick Setup – Applying

Start	Choose Region	Wireless Settings	Review Settings
<p>The Range Extender is applying the wireless settings.</p> <p><b>Completed!</b></p> <p>100%</p>			

Figure 3-10 Quick Setup – Completed



## Chapter 4 Configure the Device

This Chapter describes how to configure your Range Extender via the web-based management page. The TL-WA860RE 300Mbps Wi-Fi Range Extender with AC Passthrough is easy to configure and manage with the Web-based (Internet Explorer, Netscape® Navigator, Firefox, Safari, Opera or Chrome) management page, which can be launched on any windows, Macintosh or UNIX OS with a web browser.

After a successful login, you can configure and manage the device. There are eight main menus on the leftmost column of the web-based management page: **Status**, **Quick Setup**, **Profile**, **Network**, **Wireless**, **DHCP** and **System Tools**. Submenus will be available after clicking one of the main menus. On the right of the web-based management page are the detailed explanations and instructions for the corresponding page.

### 4.1 Status

Selecting **Status** will enable you to view the Range Extender's current status and configuration, all of which are read-only.

**Status**

Range Extender — Main Router/AP — Internet

**Range Extender Info**

- WiFi Name: TP-LINK\_TEST
- MAC Address: 00-1D-0F-86-01-02
- DHCP Server: Auto(Off)
- Channel: 11
- Wireless Connection: Connected
- IP Address: 192.168.1.100
- Type: Dynamic IP
- Signal Received From Main Router/AP: 90%
- Wireless Rate To Main Router/AP: 300.0Mbps

**Main Router/AP Info**

- WiFi Name: TP-LINK\_TEST
- MAC Address: D8-5D-4C-10-FF-22
- Internet Access: Available

Refresh

**System Up Time:** 0 days 04:24:12  
**Firmware Version:** 3.14.8 Build 140331 Rel.50795n  
**Hardware Version:** WA860RE v1.0 00000000

Figure 4-1 Status

- **Range Extender Info** - This part shows you the current information of the Range Extender.
  - **WiFi Name** - The Range Extender's wireless network name (also called SSID) which your PC and other wireless device can be connected to.
  - **MAC Address** - The physical address of the system.
  - **DHCP Server** - It shows the current status of the DHCP Server of the Range Extender.
  - **Channel** - The current wireless channel in use.

- **Wireless Connection** – It shows whether the Range Extender is connected to the Main Router/AP by Wireless.
  - **IP Address** –The IP address of the Range Extender.
  - **Type** – The Range Extender's IP address Type.
  - **Signal Received From Main Router/AP** - This is the signal strength the Range Extender received from the Main Router/AP.
  - **Wireless Rate To Main Router/AP** - This is the real wireless rate between the Range Extender and the Main Router/AP.
- **Main Router/AP Info** - This part shows you the current information of the Main Router/AP.
- **WiFi Name** - This is the WiFi name of the Main Router/AP (The Main Router/AP is usually your router or access point or gateway).
  - **MAC Address** - The MAC address of the main Router or AP.
  - **Internet Access** - It shows whether the Main Router/AP has access to the Internet.
- **System Up Time** - The length of the time since the device was last powered on or reset.
- **Firmware Version** - This field displays the current firmware version of the Range Extender.
- **Hardware Version** - This field displays the current hardware version of the Range Extender.

Click the **Refresh** button to get the latest status and settings of the device.

## 4.2 Quick Setup

Please refer to [Chapter 3 Quick Installation Guide](#).

## 4.3 Profile

Profile function can help you remember previously connected wireless networks.

You can **Edit**, **Delete** or **Add** profiles in this page (as shown in Figure 4-2) for your convenient reconnection later on.

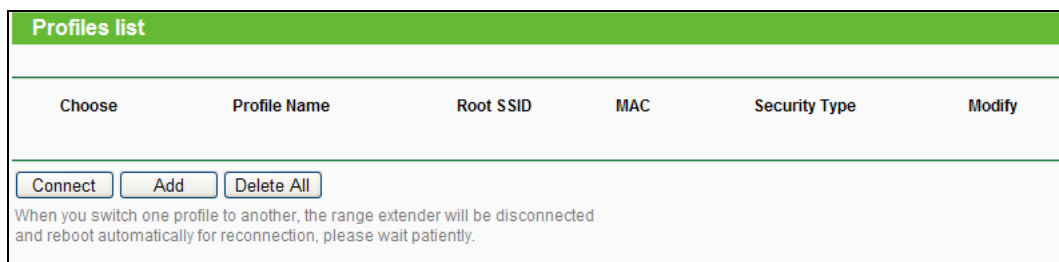

Figure 4-2 Profile

- **Choose** - You can choose any one wireless network you want to connect to.
- **Profile Name** - The name you give to your wireless networks. By default, it's the same as root SSID, but you can change it to any other names that you can easily remember and distinguish.
- **Root SSID** - the SSID (wireless network name) of your root device, a wireless router or AP.
- **MAC** - The physical address of your root AP, also called BSSID.

- **Security Type** - the security type of your root device.
- **Modify** - You can Edit or Delete the profiles.

Click **Connect** to connect the range extender to the wireless network that you have chosen in the profile list. Click **Add** to add a new profile to the list. Click **Delete All** to delete all the information in the profile list.

**To add a profile:**

1. Click **Add** in the Profile list page as shown in Figure 4-2.
2. Configure the required parameters (as shown in Figure 4-3), including name your profile, enter the SSID of your root device (a wireless router or AP) and its MAC address, select the security type of your root device and also enter the wireless password. Then click to **Save** your profile.

Figure 4-3 Add or Modify the Profile

- **Profile Name** - The name you give to your wireless networks. By default, it's the same as root SSID, but you can change it to any other names that you can easily remember and distinguish.
- **Root SSID** - The wireless network name of your root AP this profile will connect to.
- **MAC of Root Device** - The MAC of your root device this profile will connect to.
- **Wireless Security** - The security type of your root wireless networks this profile will refer to. Please make sure it's the same as the root AP's.
- **Wireless Password** - The wireless password of your root AP. Please make sure it's the same as your root AP.

Click **Save** to save this profile in the profile list and go back to the Profile List page.

Click **Back** to go back to the Profile List page, without saving any configuration on this page.

3. After you've set and saved the profile, it will return to the profile list page and display as in Figure 4-4.

Choose	Profile Name	Root SSID	MAC	Security Type	Modify
<input type="checkbox"/>	Home	TP-LINK_Network	00-0C-6D-2F-3C-BE	WPA2-PSK	<a href="#">Edit</a> <a href="#">Delete</a>

Figure 4-4 Add or Modify the Profile

Click **Edit** to further edit the profile(s), or **Delete** to delete the profile(s).

Click **Connect** to connect the range extender to the wireless network that you have chosen in the profile list.

Click **Add** to add a new profile to the list.

Click **Delete All** to delete all the information in the profile list.

## 4.4 Network

The **Network** option allows you to customize your local network manually by changing the default settings of the Range Extender. There are three submenus under the DHCP menu: **LAN**, **DHCP Settings** and **DHCP Client List**. Clicking one of them will enable you to configure the corresponding function. The detailed explanations for each submenu are provided below.

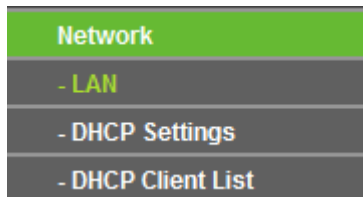

Figure 4-5 Network Menu

### 4.4.1 LAN

Selecting **Network > LAN** will enable you to configure the IP parameters of Network on this page.

LAN

MAC Address: 62-66-B3-8B-9F-E1

Type: Dynamic IP

IP Address: 192.168.0.254

Subnet Mask: 255.255.255.0

Gateway: 0.0.0.0

Save

Figure 4-6 LAN – Smart IP (DHCP)

LAN

MAC Address: 62-66-B3-8B-9F-E1

Type: Static IP

IP Address: 192.168.0.254

Subnet Mask: 255.255.255.0

Gateway: 0.0.0.0

Save

Figure 4-7 LAN – Static IP

- **MAC Address** - The physical address of the LAN port, as seen from the LAN. The value cannot be changed.

- **Type** - Several IP types are supported, including: (1) Static IP; (2) Smart IP (DHCP), and they are explained below.
  - **Dynamic IP** - In this type, if your range extender have connected to a router, your client will dynamically get a IP Address/Gateway from the router, otherwise the client will get a IP Address/Gateway in the same network as you set below. And this type is recommended.
  - **Static IP** - In this type, you can configure IP Address/Gateway manually.
- **IP Address** - Enter the IP address of your Range Extender in dotted-decimal notation (factory default setting is 192.168.0.254).
- **Subnet Mask** - An address code that determines the size of the network. Normally use 255.255.255.0 as the subnet mask.
- **Gateway** - The gateway should be in the same subnet as your IP address.

 **Note:**

1. The IP parameters cannot be configured if you have chosen Smart IP (DHCP). In this situation the device will automatically configure the IP parameters appropriate to your need.
2. If you are not familiar with the setting items in this page, it's strongly recommended to keep the provided default values, otherwise may result in lower wireless network performance or even can't work.
3. If you choose Static IP, the domain name log in function won't work, and you have to use the IP you set to log in the Range Extender's web based utility.

#### 4.4.2 DHCP Settings

DHCP stands for Dynamic Host Configuration Protocol. The DHCP Server will automatically assign dynamic IP addresses to the computers on the network. This protocol simplifies network management and allows new wireless devices to receive IP addresses automatically without the need to manually assign new IP addresses.

Selecting **Network > DHCP Settings** will enable you to set up the Range Extender as a DHCP (Dynamic Host Configuration Protocol) server, which provides the TCP/IP configuration for all the PCs that are connected to the system on the LAN. The DHCP Server can be configured on the page (shown as Figure 4-9), only when you've set the Network LAN type as Static IP in Figure 4-6.

 **Note:**

The DHCP Settings function cannot be configured if you have chosen Smart IP (DHCP) in **Network -> LAN**, in which situation the device will help you configure the DHCP automatically as you need. The DHCP Settings page will appear as Figure 4-8.

The screenshot shows the DHCP Settings page with a green header. The 'DHCP Server' section has three radio buttons: 'Auto' (checked), 'On', and 'Off'. Below this are input fields for 'Start IP Address' (192.168.0.100), 'End IP Address' (192.168.0.199), 'Address Lease Time' (1 minutes), 'Default Gateway' (192.168.0.254), 'Default Domain', 'Primary DNS' (0.0.0.0), and 'Secondary DNS' (0.0.0.0). A 'Save' button is at the bottom.

Figure 4-8 DHCP Settings – Auto

The screenshot shows the DHCP Settings page with a green header. The 'DHCP Server' section has three radio buttons: 'Auto', 'On' (checked), and 'Off'. Below this are input fields for 'Start IP Address' (192.168.0.100), 'End IP Address' (192.168.0.199), 'Address Lease Time' (1 minutes), 'Default Gateway' (192.168.0.254), 'Default Domain', 'Primary DNS' (0.0.0.0), and 'Secondary DNS' (0.0.0.0). A 'Save' button is at the bottom.

Figure 4-9 DHCP Settings – On

The screenshot shows the DHCP Settings page with a green header. The 'DHCP Server' section has three radio buttons: 'Auto', 'On', and 'Off' (checked). Below this are input fields for 'Start IP Address' (192.168.0.100), 'End IP Address' (192.168.0.199), 'Address Lease Time' (1 minutes), 'Default Gateway' (192.168.0.254), 'Default Domain', 'Primary DNS' (0.0.0.0), and 'Secondary DNS' (0.0.0.0). A 'Save' button is at the bottom.

Figure 4-10 DHCP Settings – Off

- **DHCP Server** - Selecting the radio button before **Auto/On/Off** will disable/enable the DHCP server on your Range Extender. The default setting is **Auto**. If you disable the Server, you must have another DHCP server within your network or else you must manually configure the computer.
- **Start IP Address** - This field specifies the first address in the IP Address pool. 192.168.0.100 is the default start IP address.
- **End IP Address** - This field specifies the last address in the IP Address pool. 192.168.0.199 is the default end IP address.

- **Address Lease Time** - Enter the amount of time for the PC to connect to the Range Extender with its current assigned dynamic IP address. The time is measured in minutes. After the time is up, the PC will be automatically assigned a new dynamic IP address. The range of the time is 1 ~ 2880 minutes. The default value is 120 minutes.
- **Default Gateway (optional)** - Enter the IP address of the gateway for your LAN. The factory default setting is 0.0.0.0.
- **Default Domain (optional)** - Enter the domain name of the your DHCP server. You can leave the field blank.
- **Primary DNS (optional)** - Enter the DNS IP address provided by your ISP. Consult your ISP if you don't know the DNS value. The factory default setting is 0.0.0.0.
- **Secondary DNS (optional)** - Enter the IP address of another DNS server if your ISP provides two DNS servers. The factory default setting is 0.0.0.0.

Click **Save** to save the changes.

 **Note:**

To use the DHCP server function of the device, you should configure all computers in the LAN as "Obtain an IP Address automatically" mode. This function will not take effect until the device reboots.

### 4.4.3 DHCP Client List

Selecting **Network > DHCP Client List** will enable you to view the Client Name, MAC Address, Assigned IP and Lease Time for each DHCP Client attached to the device (Figure 4-11).

DHCP Client List				
ID	Client Name	MAC Address	Assigned IP	Lease Time
1	tplink16461	50-E5-49-C8-E2-7A	192.168.0.101	00:00:51

Figure 4-11 DHCP Clients List

- **ID** – It displays the index of the DHCP client.
- **Client Name** – The Client Name displays the name of the DHCP client.
- **MAC Address** – The MAC Address displays the MAC address of the DHCP client.
- **Assigned IP** – The Assigned IP displays the IP address that the Range Extender has allocated to the DHCP client.
- **Lease Time** - It displays the time of the DHCP client leased. Before the time is up, DHCP client will request to renew the lease automatically.

You cannot change any of the values on this page. To update this page and to show the current attached devices, click on the **Refresh** button.

## 4.5 Wireless

The **Wireless** option, improving functionality and performance for wireless network, can help you make the Range Extender an ideal solution for your wireless network. Here you can create a

wireless local area network just through a few settings. Wireless Settings is used for the configuration of some basic parameters of the Range Extender. Wireless Security provides three different security types to secure your data and thus provide greater security for your wireless network. MAC filtering allows you to control the access of wireless stations to the Range Extender. Wireless Advanced allows you to configure some advanced parameters for the Range Extender. Throughput Monitor helps to watch wireless throughput information Wireless statistics enables you to get detailed information about the current connected wireless stations.

There are six submenus under the Wireless menu (shown in Figure 4-12): **Wireless Settings**, **Wireless Security**, **Wireless MAC Filtering**, **Wireless Advanced**, **Wireless Statistics** and **Throughput Monitor**. Click any of them, and you will be able to configure the corresponding function. The detailed explanations for each submenu are provided below.

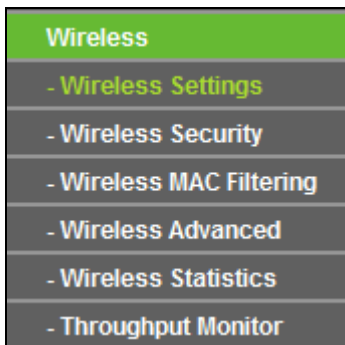

Figure 4-12 Wireless menu

### 4.5.1 Wireless Settings

Selecting **Wireless > Wireless Settings** will enable you to configure the basic settings for your wireless network on the screen below (Figure 4-13). This page allows you to configure the wireless mode for your device.

The screenshot shows the 'Wireless Settings' configuration page. It features a green header with the title 'Wireless Settings'. The main content area contains several configuration options:
 

- Operation Mode:** A dropdown menu set to 'Universal Mode'.
- Region:** A dropdown menu set to 'Please Select Your Region'. Below it is a note: 'Ensure you select a correct country to conform local law. Incorrect settings may cause interference.' and a 'Survey' button.
- Main Router/AP WiFi Network Name(SSID):** A text input field containing 'TP-LINK\_Network'.
- MAC Address of Main Router/AP:** A text input field containing '94-0C-6D-2F-3C-BE'.
- Range Extender WiFi Network Name(SSID):** A text input field containing 'TP-LINK\_Extender\_8B9FE1'.
- Channel Width:** A dropdown menu set to 'Auto'.

 At the bottom of the page is a 'Save' button.

Figure 4-13 Wireless Settings

**Note:**

Per FCC regulations, all Wi-Fi products marketed in the U.S. must be fixed to the U.S. region only.



- **Operation Mode** - Two Operation Modes are supported in most of regions, including Universal Mode and WDS Mode. And some regions also support Proxy Mode.
  - **Universal Mode** - The range extender is compatible with most routers and access points in this mode.
  - **WDS Mode** - Please choose this mode if your main router or access point works in WDS mode (uses a 4-address frame format to interact with stations).
  - **Proxy Mode** - This mode has the best compatibility with routers and access points of all brands. If your range extender has problem working in Universal Mode and WDS Mode, please choose Proxy Mode. However, it may decrease the overall performance.
- **Region** - Select your region from the drop-down list. This field specifies the region where the wireless function of this device can be used. It may be illegal to use the wireless function of this device in a region while you chose a different region in the drop-down list. If your country or region is not listed, please contact your local government agency for assistance.
- **Survey** - Click this button, you can search the AP which runs in the current channel.
- **Main Router/AP WiFi Network Name (SSID)** - The SSID of the AP your device is going to connect to as a client. You can also use the search function to select the SSID to join.
- **MAC Address of Main Router/AP** - The BSSID of the AP your device is going to connect to as a client. You can also use the search function to select the BSSID to join.
- **Range Extender WiFi Network Name (SSID)** - The wireless network name (also called SSID) of the device which your PC or other device can be connected to.
- **Channel Width** - The bandwidth of the wireless channel.

To apply any settings you have altered on the page, please click the **Save** button, and then you will be reminded to reboot the device.

#### 4.5.2 Wireless Security

Selecting **Wireless > Wireless Security** will enable you to configure wireless security for your wireless network to protect your data from intruders. The Range Extender provides two security types: WEP and WPA/WPA2-Personal. Wireless security can be set on the following screens. Since the configurations are almost the same in either operation mode, here we just take that in Range Extender mode 1 for example.

Figure 4-14 Wireless Security

- **Operation Mode** - Shows the current operation mode.
- **Disable Security** - Check this box radio button to disable wireless security. If disabled, the wireless stations will be able to connect this device without encryption. It is strongly recommended that you choose one of the security types to enable security.
- **WPA/ WPA2-Personal** - Select WPA based on pre-shared key.
  - **Version** - You can select one of following versions.
    - 1) **Automatic** - Select **WPA-PSK** or **WPA2-PSK** automatically based on the wireless station's capability and request.
    - 2) **WPA-PSK** - Pre-shared key of WPA.
    - 3) **WPA2-PSK** - Pre-shared key of WPA2.
  - **Encryption** - When you select **WPA-PSK** or **WPA2-PSK** for **Authentication Type**, you can select **Automatic**, **TKIP** or **AES** as **Encryption**.
  - **Wireless Password** - Enter a passphrase here.
  - **Group Key Update Period** - Specify the group key update interval in seconds. The value can be either 0 or at least 30. Enter 0 to disable the update.
- **WEP** - Select 802.11 WEP security.
  - **Type** - You can select one of following types.
    - 1) **Automatic** - Select **Shared Key** or **Open System** authentication type automatically based on the wireless station's capability and request.

- 2) **Shared Key** - Select 802.11 **Shared Key** authentication type.
- 3) **Open System** - Select 802.11 **Open System** authentication type.
- **WEP Key Format** - You can select **ASCII** or **Hexadecimal** format. ASCII format stands for any combination of keyboard characters in the specified length. Hexadecimal format stands for any combination of hexadecimal digits (0-9, a-f, A-F) in the specified length.
- **WEP Key** - Select which of the four keys will be used and enter the matching WEP key information for your network in the selected key radio button. These values must be identical on all wireless stations in your network.
- **Key Type** - You can select the WEP key length (**64-bit**, or **128-bit**, or **152-bit**.) for encryption. "Disabled" means this WEP key entry is invalid.
  - 1) For **64-bit** encryption - You can enter 10 hexadecimal digits (any combination of 0-9, a-f, A-F, zero key is not permitted) or 5 ASCII characters.
  - 2) For **128-bit** encryption - You can enter 26 hexadecimal digits (any combination of 0-9, a-f, A-F, zero key is not permitted) or 13 ASCII characters.
  - 3) For **152-bit** encryption - You can enter 32 hexadecimal digits (any combination of 0-9, a-f, A-F, zero key is not permitted) or 16 ASCII characters.

 **Note:**

If you do not set the key, the wireless security function is still disabled even if you have selected Shared Key as Authentication Type.

Be sure to click the **Save** button to save your settings on this page.

### 4.5.3 Wireless MAC Filtering

Selecting **Wireless > Wireless MAC Filtering** will allow you to set up some filtering rules to control wireless stations accessing the device, which depend on the station’s MAC address on the following screen as shown Figure 4-15. Since the configurations are almost the same in either operation mode, here we just take that in Range Extender mode 1 for example.

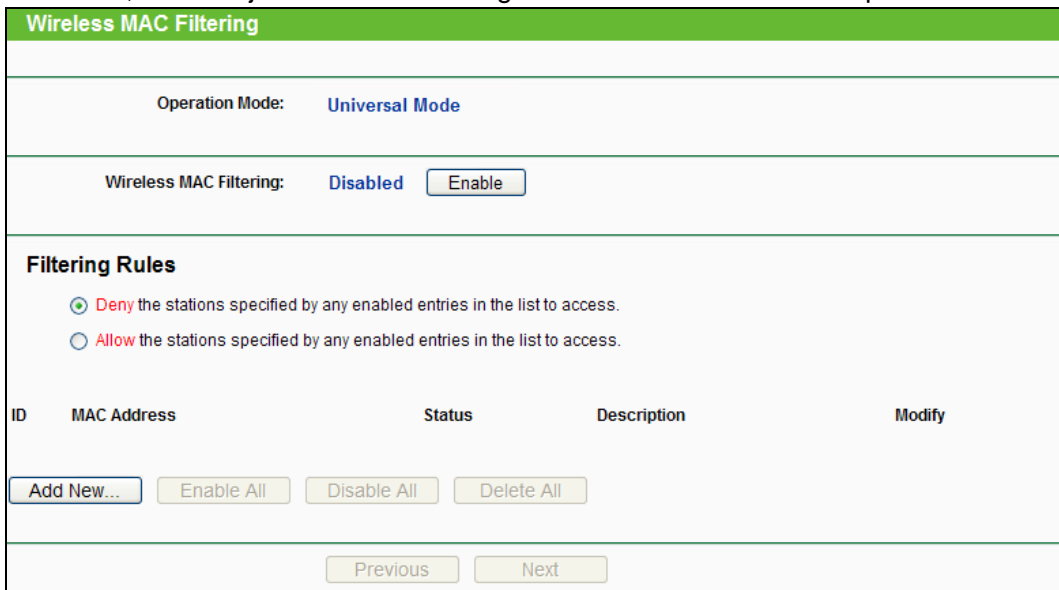

Figure 4-15 Wireless MAC address Filtering

The Wireless MAC Address Filtering feature allows you to control wireless stations accessing the device, which depend on the station's MAC addresses.

- **Operation Mode** - Shows the current operation mode.
- **Wireless MAC Filtering** - Click the **Enable** button to trigger the Wireless MAC Address Filtering function. The default setting is disabled.

To Add a Wireless MAC Address filtering entry, click the **Add New...** button. The "Add or Modify Wireless MAC Address Filtering entry" page will appear, shown in Figure 4-16.

Figure 4-16 Add or Modify Wireless MAC Address Filtering entry

- **MAC Address** - Enter the wireless station's MAC address that you want to control.
- **Description** - Give a simple description of the wireless station.
- **Status** - Select a status for this entry, either **Enabled** or **Disabled**.

#### To set up an entry, follow these instructions:

First, you must decide whether the unspecified wireless stations can access the device or not. If you desire that the unspecified wireless stations can access the device, please select the radio button **Allow the stations not specified by any enabled entries in the list to access**, otherwise, select the radio button **Deny the stations not specified by any enabled entries in the list to access**.

#### To add a MAC Address Filtering entry, follow these instructions:

1. Enter the appropriate MAC Address into the **MAC Address** field. The format of the MAC Address is XX-XX-XX-XX-XX-XX (X is any hexadecimal digit). For example: 00-0A-EB-B0-00-0B.
2. Enter a simple description of the wireless station in the **Description** field. For example: Wireless station A.
3. Select **Enabled** or **Disabled** for this entry on the **Status** pull-down list.
4. Click the **Save** button to save this entry.

To add additional entries, repeat steps 1-4.

#### To modify or delete an existing entry:

1. Click the **Modify** in the entry you want to modify. If you want to delete the entry, click the **Delete**.
2. Modify the information.
3. Click the **Save** button.

Click the **Enable All** button to make all entries enabled

Click the **Disable All** button to make all entries disabled.

Click the **Delete All** button to delete all entries

Click the **Next** button to go to the next page and click the **Previous** button to return to the previous page.

**For example:** If you desire that the wireless station A with MAC address 00-0A-EB-00-07-BE is able to access the device, while all other wireless stations cannot access the device, you should configure the **Wireless MAC Address Filtering** list by following these steps:

1. Click the **Enable** button to enable this function.
2. Select the radio button: **Deny the stations not specified by any enabled entries in the list to access** for **Filtering Rules**.
3. Delete all or disable all entries if there are any entries already.
4. Click the **Add New...** button and enter the MAC address 00-0A-EB-00-07-BE in the **MAC Address** field, enter Wireless Station A in the **Description** field and select **Enabled** in the **Status** pull-down list. Click the **Save** button.

The filtering rules that configured should be similar to the following list:

ID	MAC Address	Status	Description	Modify
1	00-0A-EB-00-07-BE	Enabled	wireless station A	<a href="#">Modify</a> <a href="#">Delete</a>

**Note:**

If you enable the function and select the **“Deny the stations not specified by any enabled entries in the list to access”** for **Filtering Rules**, and there are not any enabled entries in the list, thus, no wireless stations can access the device.

#### 4.5.4 Wireless Advanced

Selecting **Wireless > Wireless Advanced** will allow you to do some advanced settings for the device in the following screen shown in Figure 4-17. Since the configurations are almost the same in either operation mode, here we just take that in Range Extender mode 1 for example.

Figure 4-17 Wireless Advanced

- **Operation Mode** - Shows the current Operation Mode.
- **Transmit Power** - Specifies the transmit power of the device. You can select **High**, **Middle** or **Low** which you would like. **High** is the default setting and is recommended.
- **Beacon Interval** - Specifies a value between 40-1000 milliseconds. The beacons are the packets sent by the device to synchronize a wireless network. Beacon Interval value determines the time interval of the beacons. The default value is 100.
- **RTS Threshold** - Specifies the RTS (Request to Send) Threshold. If the packet is larger than the specified RTS Threshold size, the device will send RTS frames to a particular receiving station and negotiate the sending of a data frame. The default value is 2346.
- **Fragmentation Threshold** - This value is the maximum size determining whether packets will be fragmented. Setting the Fragmentation Threshold too low may result in poor network performance since excessive packets. 2346 is the default setting and is recommended.
- **DTIM Interval** - Determines the interval of the Delivery Traffic Indication Message (DTIM). You can specify the value between 1-255 Beacon Intervals. The default value is 1, which indicates the DTIM Interval is the same as Beacon Interval.
- **Enable WMM** - WMM function can guarantee the packets with high- priority messages being transmitted preferentially. It is strongly recommended enabled.
- **Enable Short GI** - This function is recommended for it will increase the data capacity by reducing the guard interval time.
- **Enable AP Isolation** - Isolates all connected wireless stations so that wireless stations cannot access each other through WLAN.

#### 4.5.5 Wireless Statistics

Selecting **Wireless > Wireless Statistics** will allow you to see the wireless transmission information in the following screen shown in Figure 4-18.

Wireless Statistics					
Operation Mode: <b>Universal Mode</b>					
Current Connected Wireless Stations numbers: <b>4</b> <input type="button" value="Refresh"/>					
ID	MAC Address	Current Status	Received Packets	Sent Packets	Configure
1	C4-6A-B7-69-CA-21	WPA2-PSK	240	210	<input type="button" value="Deny"/>
2	00-1D-0F-01-50-90	STA-ASSOC	126	3	<input type="button" value="Deny"/>
3	20-54-76-88-9F-4D	STA-ASSOC	290	260	<input type="button" value="Deny"/>
4	A8-26-D9-EE-3F-84	STA-ASSOC	1028	1010	<input type="button" value="Deny"/>
<input type="button" value="Previous"/> <input type="button" value="Next"/>					

Figure 4-18 Statistics of the device attached wireless stations

- **Operation Mode** - Shows the current operation mode.
- **MAC Address** - Shows the connected wireless station's MAC address.

- **Current Status** - The connected wireless station's running status, one of STA-AUTH / STA-ASSOC / STA-JOINED / WPA / WPA-PSK / WPA2 / WPA2-PSK / AP-UP / AP-DOWN / Disconnected.
- **Received Packets** - packets received by the station.
- **Sent Packets** - packets sent by the station.

You cannot change any of the values on this page. To update this page and to show the current connected wireless stations, click the **Refresh** button.

If the numbers of connected wireless stations go beyond one page, click the **Next** button to go to the next page and click the **Previous** button to return the previous page.

**Note:**

This page will be refreshed automatically every 5 seconds.

### 4.5.6 Throughput Monitor

Selecting **Wireless > Throughput Monitor** will help to watch wireless throughput information in the following screen shown in Figure 4-19.

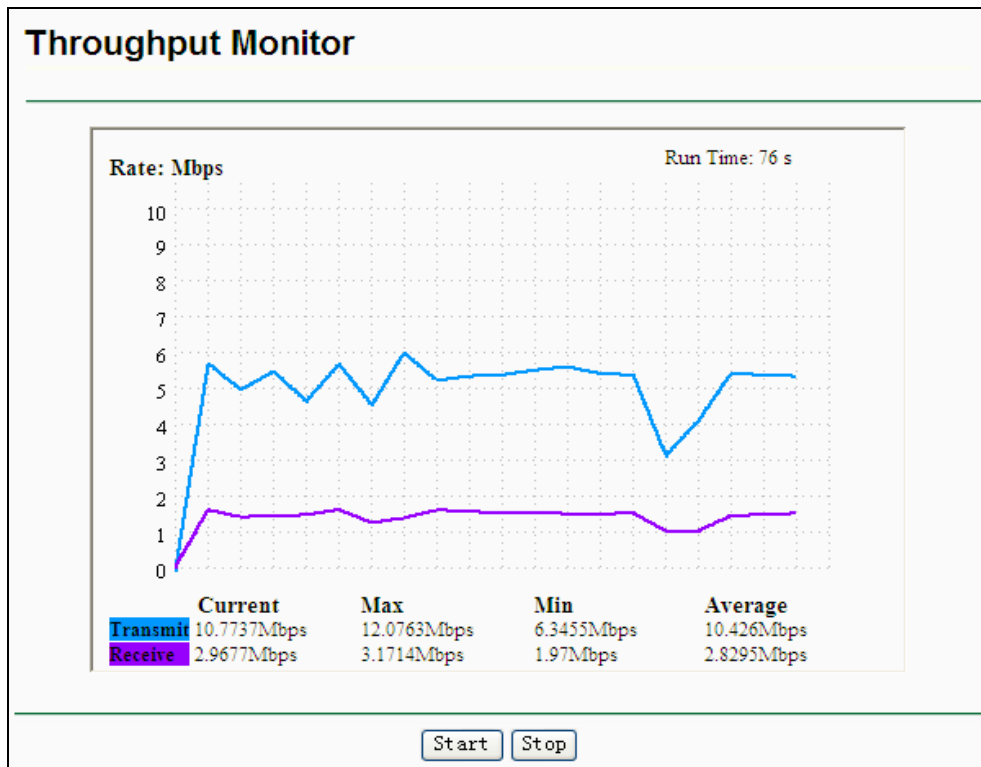

Figure 4-19 Throughput Monitor

- **Rate** - The Throughput unit.
- **Run Time** - How long this function is running.
- **Transmit** - Wireless transmit rate information.
- **Receive** - Wireless receive rate information.

Click the **Start** button to start wireless throughput monitor.

Click the **Stop** button to stop wireless throughput monitor.

## 4.6 System Tools

**System Tools** option helps you to optimize the configuration of your device. You can upgrade the Range Extender to the latest version of firmware as well as backup or restore the Range Extender's configuration files. It's suggested that you change the default password to a more secure one because it controls access to the device's web-based management page. Besides, you can find out what happened to the system in System Log.

There are six submenus under the **System Tools** menu (shown as Figure 4-20): **Firmware Upgrade**, **Factory Defaults**, **Backup & Restore**, **Reboot**, **Password**, and **System Log**. Clicking any of them will enable you to configure the corresponding function. The detailed explanations for each submenu are provided below.

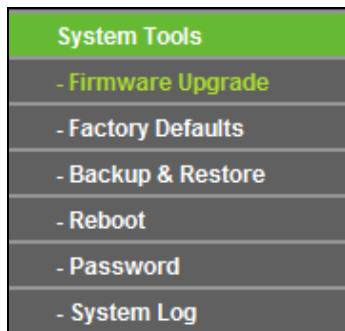

Figure 4-20 The System Tools menu

### 4.6.1 Firmware Upgrade

Selecting **System Tools > Firmware Upgrade** allows you to upgrade the latest version of firmware for the device on the screen shown in Figure 4-21.

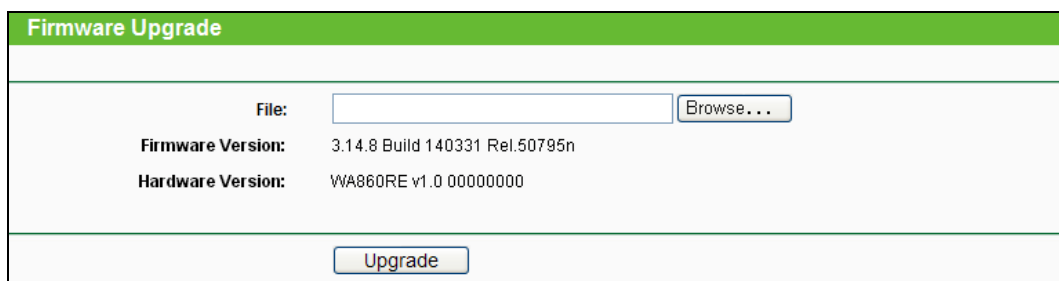

Figure 4-21 Firmware Upgrade

New firmware versions are posted at <http://www.tp-link.com> and can be downloaded for free.

- **Firmware Version** - Displaying the current firmware version.
- **Hardware Version** - Displaying the current hardware version. The hardware version of the upgrade file must accord with the current hardware version.

 **Note:**

1. There is no need to upgrade the firmware unless the new firmware has a new feature you want to use. However, when experiencing problems caused by the device itself, you can try to upgrade the firmware.
2. Before upgrading the device's firmware, you should write down some of your customized settings to avoid losing important configuration settings of device.

**To upgrade the device's firmware, follow these instructions:**



1. Download a more recent firmware upgrade file from the TP-LINK website (<http://www.tp-link.com>).
2. Enter the path name or click **Browse...** to select the downloaded file on the computer into the **File** blank.
3. Click **Upgrade**.

 **Note:**

Do not turn off the device or press the **Reset** button while the firmware is being upgraded. The device will reboot after the Upgrading has been finished.

#### 4.6.2 Factory Defaults

Selecting **System Tools > Factory Default** allows you to restore the factory default settings for the device on the screen shown in Figure 4-22.

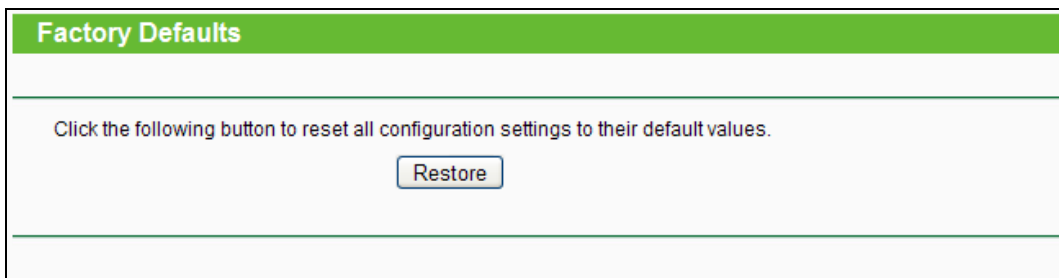

Figure 4-22 Restore Factory Defaults

Click **Restore** to reset all configuration settings to their default values.

- Default **User Name**: admin
- Default **Password**: admin
- Default **IP Address**: 192.168.0.254
- Default **Subnet Mask**: 255.255.255.0

 **Note:**

Any settings you have saved will be lost when the default settings are restored.

#### 4.6.3 Backup & Restore

Selecting **System Tools > Backup & Restore** allows you to save all configuration settings to your local computer as a file or restore the device's configuration on the screen shown in Figure 4-23.

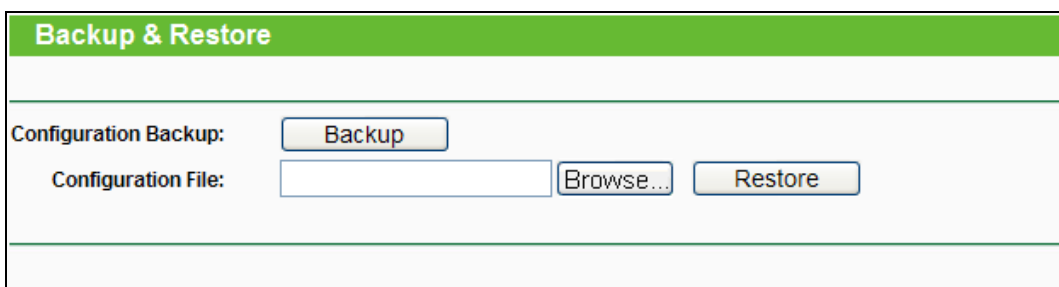

Figure 4-23 Save or Restore the Configuration

Click **Backup** to save all configuration settings to your local computer as a file.

To restore the device's configuration, follow these instructions:

- Click **Browse...** to find the configuration file which you want to restore.
- Click **Restore** to update the configuration with the file whose path is the one you have input or selected in the blank.

 **Note:**

The current configuration will be covered with the uploading configuration file. Wrong process will lead this device unmanaged. The restoring process lasts for 20 seconds and this device will restart automatically then. Keep the power of this device on during the process, in case of any damage.

#### 4.6.4 Reboot

Selecting **System Tools > Reboot** allows you to reboot the device on the screen shown in Figure 4-24.

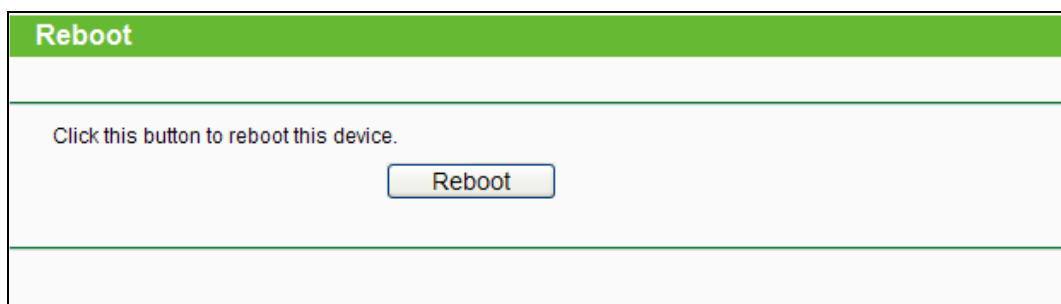

Figure 4-24 Reboot the device

Click the **Reboot** button to reboot the device.

Some settings of the device will take effect only after rebooting, which include:

- Change LAN IP Address (System will reboot automatically).
- Change the Wireless configurations.
- Change the Web Management Port.
- Upgrade the firmware of the device (system will reboot automatically).
- Restore the device's settings to factory defaults (system will reboot automatically).
- Update the configuration with a file (system will reboot automatically).

### 4.6.5 Password

Selecting **System Tools > Password** allows you to change the factory default user name and password of the device on the screen shown in Figure 4-25.

Figure 4-25 Password

It is strongly recommended that you change the factory default user name and password of the device. All users who try to access the device's web-based management page or Quick Setup will be prompted for the device's user name and password.

**Note:**

The new user name and password must not exceed 14 characters in length and must not include any spaces. Enter the new Password twice to confirm it.

Click **Save** when finished.

Click **Clear All** to clear all.

### 4.6.6 System Log

Selecting **System Tools > System Log** allows you to query the Logs of the device on the screen shown in Figure 4-26.

Index	Time	Type	Level	Log Content
1	1st day 00:00:06	OTHER	INFO	System started

H-Ver = WA860RE v1.0 00000000 : S-Ver = 3.14.8 Build 140331 Rel.50795n  
 L = 192.168.1.100 : M = 255.255.255.0  
 W1 = DHCP : W = 192.168.1.100 : M = 255.255.255.0 : G = 192.168.1.1

Figure 4-26 System Log

The device can keep logs of all traffic. You can query the logs to find what happened to the device.

- **Log Type** - By selecting the log type, only logs of this type will be shown.
- **Log Level** - By selecting the log level, only logs of this level will be shown.

Click the **Refresh** button to show the latest log list.

Click the **Save Log** button to save all the logs in a txt file.

Click the **Clear Log** button to delete all the logs from the system permanently, not just from the page.

Click the **Next** button to go to the next page, or click the **Previous** button return to the previous page.

## Appendix A: Factory Defaults

Item	Default Value
<b>Common Default Settings</b>	
Username	admin
Password	admin
IP Address	192.168.0.254
Subnet Mask	255.255.255.0
Domain	http://tplinkrepeater.net
<b>Wireless</b>	
SSID	TP-LINK_Extender_XXXXXX
Wireless Security	Disabled
Wireless MAC Address Filtering	Disabled

 **Note:**

The default SSID is TP-LINK\_Extender\_XXXXXX (XXXXXX indicates the last unique six characters of each device's MAC address). This value is case-sensitive.

## Appendix B: Troubleshooting

### T1. How do I restore my Range Extender's configuration to its factory default settings?

There are TWO methods available to restore the factory defaults.

#### Method 1:

With the Range Extender powered on, press and hold the **RESET** button (about 6 seconds) until all the LEDs turn on momentarily, then release the button and wait the Range Extender to reboot to its factory default settings.

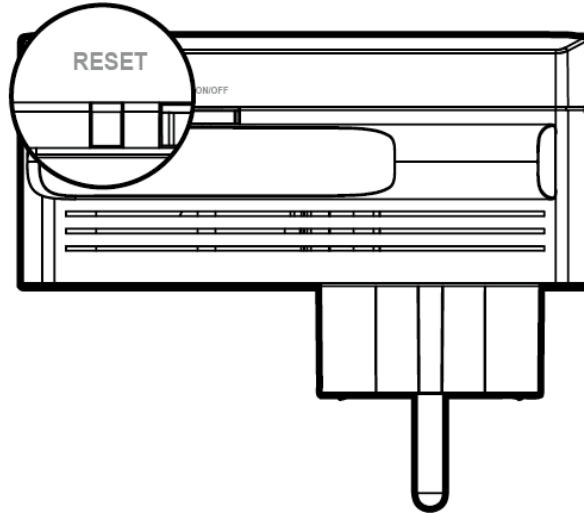

#### Method 2:

Get logged in to the web-based management page of TL-WA860RE, then go to "**System Tools -> Factory Defaults**" and click "**Restore**".

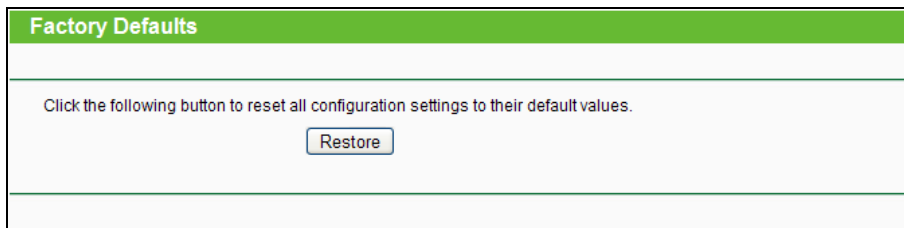

#### **Note:**

Once the Range Extender is reset, the current configuration settings will be lost and you will need to reconfigure it.

### T2. What can I do if I forget my password?

- 1) Restore the Range Extender's configuration to its factory default settings. If you don't know how to do that, please refer to previous **T1**;
- 2) Use the default user name and password: **admin, admin**;
- 3) Try to reconfigure your Range Extender by following the instructions of this UG.

### T3. What can I do if I cannot access the web-based configuration page?

- 1) Check to verify all the connections (either wireless or wired ones) are proper. If yes, please proceed to the next step; otherwise, check the connections again.
- 2) Try to obtain an IP address and gateway; if succeed, open your web-browser, enter the default domain <http://tplinkrepeater.net> in the address field and get logged in.  
If you are unable to log in, please **RESET** the device, and then use the default IP address to get into the web-based configuration page, reconfigure the device.
- 3) Feel free to contact our technical support, if the problem still persists.

**T4. How can I know that my wireless signal has been repeated and boosted by TL-WA860RE?**

An easy way is to compare the signal strength of your target wireless network (symbolized by its SSID), with TL-WA860RE in operation vs. out of operation. Before comparison, you'd better make sure your computer can obtain an IP address from your target wireless network and thus access the Internet, either via TL-WA860RE or without.

**T5. Will the Range Extender work if I connect the ETHERNET port of it to the router via Ethernet cable?**

Sorry, it won't work. The Range Extender is designed to connect wirelessly to the router, while the ETHERNET port is designed to connect with a wired device, like Internet TV, Gaming console, DVR and so on.

**T6. Why does the wireless transmission rate speed down, while the wireless signal is stronger after repeated by TL-WA860RE?**

In compliance with the wireless transmission protocol, all the Range Extender devices are set to work in half-duplex instead of full-duplex mode. In other words, the Range Extender has to process one-way communication between your root Wireless router (or AP) and the terminal clients; so the transmission time will be double-increased, while the speed will be decreased. TP-LINK recommends that you connect to the Range Extender when your home network connection is poor, or when you want a larger wireless coverage to eliminate "dead zones".

## Appendix C: Specifications

General	
Standards and Protocols	IEEE 802.3, 802.3u, 802.11n, 802.11b and 802.11g, TCP/IP, DHCP
Safety & Emission	CE
Ports	One 10/100M Auto-Negotiation LAN RJ45 port
Wireless	
Frequency Band	2.4~2.4835GHz
Radio Data Rate	11n: up to 300Mbps (Automatic) 11g: 54/48/36/24/18/12/9/6M (Automatic) 11b: 11/5.5/2/1M (Automatic)
Frequency Expansion	DSSS (Direct Sequence Spread Spectrum)
Modulation	DBPSK, DQPSK, CCK, OFDM, 16-QAM, 64-QAM
Security	WEP, WPA-PSK, WPA2-PSK
Sensitivity @PER	270M: -68dBm@10% PER 108M: -68dBm@10% PER; 54M: -68dBm@10% PER 11M: -85dBm@8% PER; 6M: -88dBm@10% PER 1M: -90dBm@8% PER
Physical and Environment	
Working Temperature	0°C~40°C (32°F~104°F)
Working Humidity	10% ~ 90% RH, Non-condensing
Storage Temperature	-40°C~70°C(-40°F~158°F)
Storage Humidity	5% ~ 95% RH, Non-condensing



## Appendix D: Glossary

- **802.11b** - The 802.11b standard specifies a wireless networking at 11 Mbps using direct-sequence spread-spectrum (DSSS) technology and operating in the unlicensed radio spectrum at 2.4GHz, and WEP encryption for security. 802.11b networks are also referred to as Wi-Fi networks.
- **802.11g** - specification for wireless networking at 54 Mbps using direct-sequence spread-spectrum (DSSS) technology, using OFDM modulation and operating in the unlicensed radio spectrum at 2.4GHz, and backward compatibility with IEEE 802.11b devices, and WEP encryption for security.
- **802.11n** - 802.11n builds upon previous 802.11 standards by adding MIMO (multiple-input multiple-output). MIMO uses multiple transmitter and receiver antennas to allow for increased data throughput via spatial multiplexing and increased range by exploiting the spatial diversity, perhaps through coding schemes like Alamouti coding. The Enhanced Wireless Consortium (EWC) was formed to help accelerate the IEEE 802.11n development process and promote a technology specification for interoperability of next-generation wireless local area networking (WLAN) products.
- **Access Point (Range Extender)** - A wireless LAN transceiver or "base station" that can connect a wired LAN to one or many wireless devices. Access points can also bridge to each other.
- **DNS (Domain Name System)** – An Internet Service that translates the names of websites into IP addresses.
- **Domain Name** - A descriptive name for an address or group of addresses on the Internet.
- **DoS (Denial of Service)** - A hacker attack designed to prevent your computer or network from operating or communicating.
- **DSL (Digital Subscriber Line)** - A technology that allows data to be sent or received over existing traditional phone lines.
- **ISP (Internet Service Provider)** - A company that provides access to the Internet.
- **MTU (Maximum Transmission Unit)** - The size in bytes of the largest packet that can be transmitted.
- **SSID** - A **S**ervice **S**et **I**dentification is a thirty-two character (maximum) alphanumeric key identifying a wireless local area network. For the wireless devices in a network to communicate with each other, all devices must be configured with the same SSID. This is typically the configuration parameter for a wireless PC card. It corresponds to the ESSID in the wireless Access Point and to the wireless network name.
- **WEP (Wired Equivalent Privacy)** - A data privacy mechanism based on a 64-bit or 128-bit or 152-bit shared key algorithm, as described in the IEEE 802.11 standard.
- **Wi-Fi** –A trademark of the Wi-Fi Alliance and the brand name for products using the IEEE 802.11 family of standards.
- **WLAN (Wireless Local Area Network)** - A group of computers and associated devices communicate with each other wirelessly, which network serving users are limited in a local area.

- **WPA (Wi-Fi Protected Access)** - WPA is a security technology for wireless networks that improves on the authentication and encryption features of WEP (Wired Equivalent Privacy). In fact, WPA was developed by the networking industry in response to the shortcomings of WEP. One of the key technologies behind WPA is the Temporal Key Integrity Protocol (TKIP). TKIP addresses the encryption weaknesses of WEP. Another key component of WPA is built-in authentication that WEP does not offer. With this feature, WPA provides roughly comparable security to VPN tunneling with WEP, with the benefit of easier administration and use. This is similar to 802.1x support and requires a RADIUS server in order to implement. The Wi-Fi Alliance will call this, WPA-Enterprise. One variation of WPA is called WPA Pre Shared Key or WPA-Personal for short - this provides an authentication alternative to an expensive RADIUS server. WPA-Personal is a simplified but still powerful form of WPA most suitable for home Wi-Fi networking. To use WPA-Personal, a person sets a static key or "passphrase" as with WEP. But, using TKIP, WPA-Personal automatically changes the keys at a preset time interval, making it much more difficult for hackers to find and exploit them. The Wi-Fi Alliance will call this, WPA-Personal.